

# The Investigation of Conductivity of Magnetic Nanoparticles in the Vascular Network by DCC Method and the Effect of Forces on the Efficiency of Targeted Magnetic Drug Delivery

Seyed Erfan Saadatmand<sup>1</sup>, Seyede Mahsa Kavousi<sup>1</sup>, Nader Riyahi Alam<sup>1,2,3\*</sup> 

<sup>1</sup>Department of Physics and Medical Engineering, School of Medicine, Tehran University of Medical Sciences, Tehran, Iran

<sup>2</sup>PERFORM Preventive Medicine and Health Care Center, Concordia University, Montreal, Quebec, Canada

<sup>3</sup>Medical Pharmaceutical Sciences Research Center, The institute of Pharmaceutical Sciences, Tehran University of Medical Sciences, Tehran, Iran

\*Corresponding Author: Nader Riyahi Alam  
Email: [riahialam@gmail.com](mailto:riahialam@gmail.com)

Received: 13 September 2020 / Accepted: 07 December 2020

## Abstract

**Purpose:** Targeted magnetic drug delivery is one of the methods of cancer treatment. In this method, magnetic factors are conducted inside the body by a variable external magnetic field and deliver the drug agents to the tumor area. The present study aimed to investigate the performance of the drug magnetic conduction by using Differential Current Coil (DCC) and the effect of gravity force on it.

**Materials and Methods:** In mathematical modeling, magnetic, hydrodynamic and gravity forces were assumed to affect the movement of magnetic nanoparticles inside the vessels. Helmholtz coils with a circular cross-section and different currents were simulated in the software environment. The trajectory of nanoparticles within the static fluid, Y-shape channel and multi-branch vascular network was calculated. The relations between the magnetic force applied on the magnetic nanoparticles and the parameters of coil flow, radius and relative permeability of the nanoparticles were investigated.

**Results:** The magnetic flux generated in the coils was calculated and the particles moved in the direction of the magnetic gradient. The diagram of magnetophoresis force changes with the physical parameters was calculated. Particle trajectory and correct exit rate were obtained in simulated vessels. The output changes in the state of with-the-effect and without-the-effect of gravity were about 1.5 to 3%. The output changes of the correct and incorrect branches were calculated by changing the angle of the branches.

**Conclusion:** From the approximate reduction of 2% of the correct output, it can be concluded that the effect of gravity on the conductivity of the system can be neglected. Besides, it seems that as the injection point is closer to the conduction point, the amount of the correct output will increase more.

**Keywords:** Targeted Drug Delivery; Simulation; Magnetic Nanoparticles; Blood Vessel; Comsol Multiphysics.

## 1. Introduction

Targeted drug delivery is an important therapeutic method in cancer treatment. In this method, drug agents are loaded on biocompatible carriers and then they are released in an interested area by a controlling factor [1]. The controlling factor in this method is an external magnetic field. In conventional drug delivery, despite releasing drug agents in the interested region, they spread in healthy tissues, either. Whereas, in targeted drug delivery, drugs mostly concentrate on the diseased area and prevent the presence of drugs in healthy tissues. Nanosize carriers have advantages like biodegradability, subcellular dimensions and good performance in targeting. Hence, using these carriers in drug delivery systems reached importance in recent decades. Furthermore, magnetic nanoparticle characteristics like being superparamagnetic and high saturation magnetization cause these particles as proper particles in drug delivery. The important characteristic of using nanoparticles in magnetic drug delivery is the ability to control them with an external magnetic field to reaching them into the desired area. By loading magnetic nanoparticles with proper drugs, the magnetic capturing of drugs to destroying tumors can occur. Using some physiological changes after concentrating the drugs near the tumor, the drugs are offloaded from the carriers and are absorbed by the tumor [2].

Drug delivery research based on magnetic nanoparticles is generally divided into two categories. The first part deals with the synthesis and properties of magnetic nanoparticles for drug delivery [3-5]. The other part is about the design of conducting and transferring systems of magnetic nanoparticles from the injection point to the interested point in the vascular system. Initially, magnetic nanoparticles were captured by a static and uniform magnetic field created by a permanent magnet or a superconducting magnet [6, 7]. However, using the constant and uniform magnetic field for targeting magnetic particles did not have a good effect on the deep region inside the body. To reach deep areas inside the body, electromagnets are used as stimulants, extensively [8-11].

According to Magnetic Resonance Imaging (MRI) concepts, in drug delivery systems two different sets of Maxwell and Helmholtz coils are used in each direction for conducting and saturating particles, respectively. This design with considering conduction in three

dimensions is tremendously severe and expensive [12-14]. In one design, The Maxwell coil is eliminated and only Helmholtz coil with the DCC method is used. The basis of this method is the movement of the magnetic nanoparticles to the point with high magnetic field intensity. By increasing the current in one coil and decreasing it in another, the gradient field was generated that causes particles to be absorbed in the side of the coil with high intensity [15]. Although in a research, Lorentz and magnetization forces were intended, the gravity force was not considered and the DCC method was not utilized either [16]. In one research, the performance of the drug conduction system in a Y-shape channel equivalent to a blood vessel was investigated by using the DCC method. In this study [17], the effects of gravity and lift forces inside of the vessel has been neglected. Besides, the angle of the Y-shape channel was assumed constant.

In this study, the performance of the drug conduction system using the DCC method by considering the effects of the gravity and lift forces are investigated. Then, the effect of the double branch angle variation on the system efficiency and the relation of the correct conduction and the relative permeability of the Nanomagnetic particles are assessed. Finally, the conduction system performance in a multi-branch vessel net is modeled by Comsol multiphysics software.

## 2. Materials and Methods

### 2.1. Mathematical Modeling

The following forces are applied to a magnetic nanoparticle which is inside the blood flow and under the influence of a non-uniform external magnetic field [7]:

- 1- Hydrodynamic force caused by the pressure variation due to the heartbeat.
- 2- Magnetophoresis force generated by the external magnetic field gradient.
- 3- Gravity force and buoyancy force.
- 4- Inertia force which is against the magnetic and the hydrodynamic forces. The inertia force is usually several times less than these forces.
- 5- A force generated by the brownie movement.
- 6- Forces generated by the interaction between the nanoparticles and the fluid.

7- Forces generated by the interaction between the particles like the interaction between the magnetic moment of particles.

8- Vandervalci forces.

9- Forces generated by the interaction between the electric double layers.

In this paper, the gravity force is considered in the calculations in addition to the two dominant forces; the hydrodynamic and the magnetic. Therefore, the total force on the nanoparticle can be written as bellows:

$$F_{total} = \vec{F}_{mag} + \vec{F}_{drag} + \vec{F}_{grav} = m\vec{a} \quad (1)$$

Which  $F_{total}$ ,  $\vec{F}_{mag}$ ,  $\vec{F}_{drag}$ , and  $\vec{F}_{grav}$  are the total force on the particle, magnetic force, hydrodynamic force and the gravity force, respectively. The movement of a magnetic nanoparticle in a viscous environment and affected by the magnetic field is shown in Equation 1.

### 2.1.1. Magnetophoresis

The force on the magnetic particle with the magnetic bipolar moment  $\vec{\mu}$  in a non-uniform external magnetic field  $\vec{B}$  is shown as bellow:

$$F_{Mag} = \nabla(\vec{\mu} \cdot \vec{B}) \quad (2)$$

Which  $\vec{\mu}$  and  $\vec{B}$  are the magnetic moment vector of the particle and the system magnetic flux density, respectively. Assuming that all the magnetic moments of the particles are aligned with the external magnetic field, the magnetic moment can be written as:

$$\vec{\mu} = \frac{\mu}{\bar{\mu}} \vec{B} \quad (3)$$

With Equation 2 and 3, the magnetic force on the nanomagnetic particle with the magnetic moment of  $\mu$  can be considered as [8]:

$$\vec{F}_{Mag} = \mu(\nabla\vec{B}) \quad (4)$$

Besides, if we assume the nanoparticles as a homogeneous sphere with radius R and net magnetic polarization M suspended in a magnetically linear fluid with permeability subjected in a magnetic intensity B, as shown below, we can obtain a formula to achieve the effective magnetic moment of the sphere:

$$M_{eff} = 4\pi R^3 \left[ \frac{\mu_0 - \mu_1}{\mu_0 + 2\mu_1} B + \frac{\mu_0}{\mu_0 + 2\mu_1} M \right] \quad (5)$$

Where is the permeability of free space. For a magnetically linear particle with magnetic permeability we have:

$$M = \chi B \quad (6)$$

Where  $\chi = \frac{\mu_2}{\mu_0 - 1}$  is the susceptibility of the particle.

Here the effective moment can be simplified to:

$$M_{eff} = 4\pi R^3 \frac{\mu_0 - \mu_1}{\mu_0 + 2\mu_1} B \quad (7)$$

As shown in Equation 4, the Magnetophoretic force depends on the gradient of the magnetic field intensity ( $\nabla B$ ) and the effective magnetic moment ( $M_{eff}$ ) of the particles. Therefore, by adding  $M_{eff}$  to Equation 4 we have:

$$F_{Mag} = \mu_1 M_{eff} \cdot \nabla B \quad (8)$$

From Equation 7 and 8, the magnetophoretic force for a magnetic spherical particle in a non-uniform magnetic field can be written as:

$$F_{Mag} = 2\pi\mu_1 R^3 \frac{\mu_2 - \mu_1}{\mu_2 + 2\mu_1} \nabla B^2 \quad (9)$$

Eventually, assuming magnetization as a non-linear function of the field, for a spherical ferromagnetic particle immersed in a fluid with permeability  $\mu_1$ , using Equation 5 and 9, the MAG force can be written as:

$$F_{Mag} = 2\pi\mu_1 R^3 \left[ \frac{\mu_0 - \mu_1}{\mu_0 + 2\mu_1} \nabla B^2 + \frac{2\mu_0}{\mu_0 + 2\mu_1} M(B) \cdot \nabla B \right] \quad (10)$$

### 2.1.2. Hydrodynamic Force

The behavior of a fluid inside a channel follows Navier-Stoke's law [9]:

$$F_{drag} = 6\pi\eta r_{np} u \quad (11)$$

Where  $\eta$  is the fluid dynamic viscosity,  $r_{np}$  is the particle hydrodynamic radius and u is the particle velocity. The fluid velocity in the vessel equivalent channel follows Equation 12. In this study, the flow inside the channel and the profile of its velocity were considered linear and paraboloid, respectively [10].

$$u = 2v \left( 1 - \frac{z^2 + x^2}{R^2} \right) \quad (12)$$

Where v is the mean velocity of the fluid and R is a radius of a vessel that is aligned to Y axes of hypothetical

coordinates. The paraboloid form of the fluid velocity is explained that the velocity in the center of the vessel has the maximum amount and from the center to the walls reduces gradually and the velocity in the walls reaches zero. This is caused by the resistance of the walls against the flow. Hence, the particle which is placed in the center of the vessel has the maximum blood velocity and therefore, has the maximum hydrodynamic force. The particle velocity near the vessel walls reaches zero, inversely. From Equation 11 and 12, we can notice:

$$F_{drag} = 6\pi\eta r_{np} 2v(1 - \frac{x^2 + z^2}{R^2}) \quad (13)$$

Therefore, in targeted drug delivery we can assume that by reaching the particle near to the walls, the particle is captured ( $u=0$ ). It should be noted that the precise investigation of hydrodynamic for this application is beyond this study and had been neglected.

### 2.1.3. Gravity Force

The gravity force is explained as [10]:

$$F_{grav} = -v_p(\rho_p - \rho_f)g \quad (14)$$

Where  $\rho_p$ ,  $\rho_f$  and  $v_p$  are the particle density, the fluid density and the particle hydrodynamic volume, respectively.  $g$  is the earth gravity acceleration and equal to  $9.8 \text{ m/s}^2$ . In the hypothetical coordinates system of this study, the gravity force of the earth is along the  $z$ -axis.

### 2.1.4. Particle Trajectory

Using Newton's law, Equation 1 can be written as:

$$m \frac{d^2x}{dt^2} = \frac{4}{3} \pi \mu_0 R^3 M(B) \cdot \nabla B + 6\pi\eta\Delta v + mg \quad (15)$$

Equation 15 in three-dimension can be expanded as:

$$\begin{aligned} x: \frac{md^2x}{dt^2} &= \frac{4}{3} \pi \mu_0 R^3 M(B) \frac{\partial B}{\partial x} + 6\pi\eta\Delta v \\ y: \frac{md^2y}{dt^2} &= \frac{4}{3} \pi \mu_0 R^3 M(B) \frac{\partial B}{\partial y} + 6\pi\eta\Delta v \\ z: \frac{md^2z}{dt^2} &= \frac{4}{3} \pi \mu_0 R^3 M(B) \frac{\partial B}{\partial z} + 6\pi\eta\Delta v + mg \end{aligned} \quad (16)$$

Where  $m$ ,  $v_p$  and  $M$  are the mass, the velocity and the magnetization of the particle, respectively.  $\frac{\partial B}{\partial x}$ ,  $\frac{\partial B}{\partial y}$ , and  $\frac{\partial B}{\partial z}$  are the magnetic field gradient along  $x$ ,  $y$  and  $z$ -axes.  $\eta$  and  $\Delta v$  are the fluid viscosity and the relative velocity

(the particle velocity to the fluid velocity) of the particle inside the channel, respectively. Using the above equations, the particle location can be calculated at all time intervals.

### 2.1.5. Conduction Method

Most of the closed-loop control systems for nanoparticles use electromagnets as a stimulator. In the conduction method which is used in this study, blood flow causes movement of the particles while electromagnets are only used for rotation of the particles. Thus, the particles move forward via blood flow and applying magnetic gradient caused by electromagnets in a perpendicular direction of the velocity vector of blood flow easily conducts them into the desired branch before reaching branches. It should be noted that the positive direction of the applied magnetic field gradient should be along the desired branch. Figure 1 shows a simple model of this conduction method. Applied hydrodynamic force to the particles in a perpendicular direction of the blood flow is less than the applied hydrodynamic force in the flow direction. Thus, the demand magnetic force to overcome drag force for particle rotation is much less than the demand force to moving particles forward.

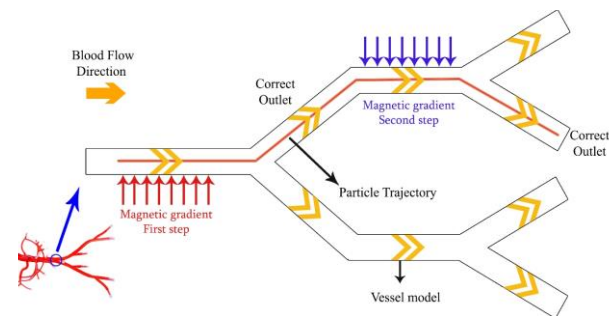


Figure 1. A simplified model of the conduction method

## 2.2. Simulation

It is necessary to know the characteristics of the magnetic field such as magnetic flux density to study the trajectory of the magnetic nanoparticles under the effect of the applied external magnetic field into a dense environment. To achieve this goal, the simulation of the proper geometry as a magnetic system was performed by multiphysics Comsol (version 5.3) software. The modeled magnetic system was in two states: a three-dimensional system consisting of three pairs of Helmholtz coils and a one-dimensional system consisting of a pair of

coils. Each simulated Helmholtz coil consisted of a cylindrical core in the center of it. The coils in the software were modeled as symmetric hollow cylinders with 9300 rounds of copper wire with a cross-section of  $10 \cdot 6 \text{ m}^2$ . The material of the core in electromagnets was considered ferrite due to its high magnetic permeability and low electrical conduction. The cores diameter and the distance between the cores from the center of the geometry was 3 cm.

The conduction system performance in two different states was studied; 1) a sphere consisting of stationary fluid was located at the center of the 3D geometry setup, 2) a Y-shape channel was placed as a blood vessel at the center of the pair coil system. Finally, the conduction of the nanoparticles was modeled in a multi-branch blood vessel net. By using the particle tracing module of the software, the particle trajectory was achieved. The nanoparticles were considered as spheres with magnetic properties. Table 1 presents the amounts and characteristics of the simulated magnetic system.

**Table 1.** The modelling Parameters of magnetic system

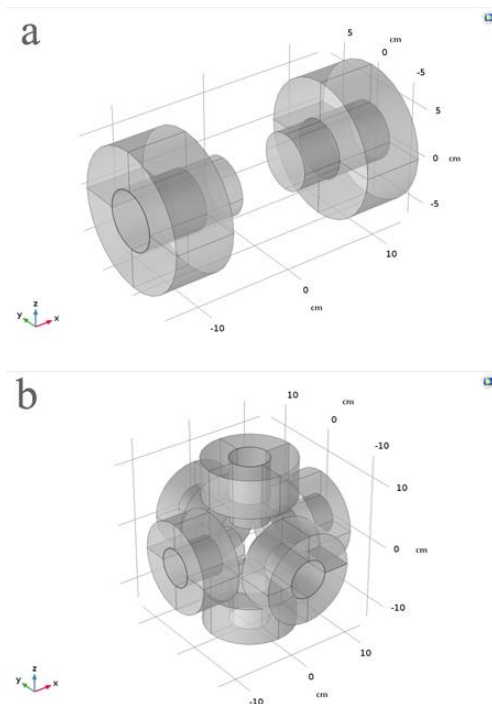
Parameter	Value	Unit
Coil width	100	mm
Coil Height	60	mm
Core Diameter	60	mm
Number of Turn	9300	-
Wire Diameter	0.6	mm

The effect of the different coil parameters on the magnetic field was studied by Comsol multiphysics software. The amount of the structural and physical parameters of the coils for simulation was performed by numerical methods [15]. AC/DC module of the software was used to simulate the magnetic system. The final geometry of the three and one-dimensional system is shown in Figure 2.

In particle tracing module of Comsol software, nanoparticles are considered as homogenous and solid spherical particles. Only parameters like density, radius and magnetic permeability of nanoparticles are intended in calculations. The desired nanoparticle is  $\text{Fe}_3\text{O}_4$  and the related parameters of it are shown in Table 2.

Figure 3 depicts the position of the sphere in a 3D setup and the modeled blood vessel between the coils.

The modeled parameters of this section are shown in Table 3.



**Figure 2.** a) 3D model of magnetic conduction system; b) The 1D model of the system, the movement of the particles is along to the x-direction

**Table 2.** The physical parameters of nanoparticle ( $\text{Fe}_3\text{O}_4$ )

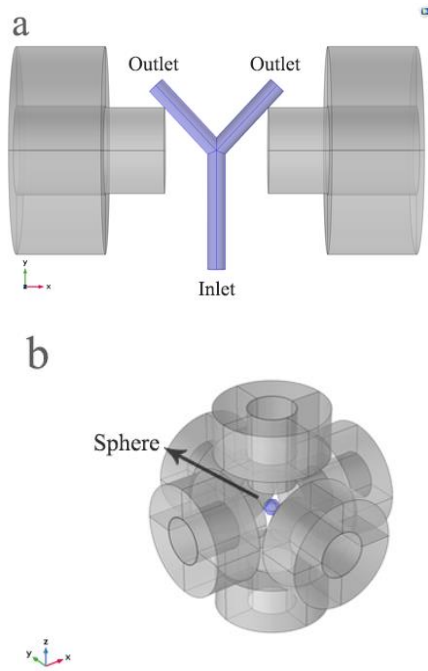
Parameter	Value	Unit
Density	7200	$\text{Kg/m}^3$
Radius	450	nm
Relative Permeability	5000	-

### 3. Results

The magnetic flux of the 3D setup in the case which coils current along the x-axis was 10 A and the other coils were 0 was calculated by magnetic field physic in a stationary state (Figure 4). To investigate the particle movement in the 3D system, a  $1 \mu\text{m}$  diameter particle was released without velocity at the center of a motionless water sphere. The particle trajectory was achieved by particle tracing physic and time-dependent study for 60 seconds.

This operation was accomplished for three different states of coils current. Indexes of + and - represent the current coil in the positive and the negative direction of the axis, respectively.





**Figure 3.** a) The placement of the Y-shape channel between the coils, the sizes are different from the simulation model; b) Water sphere in three-dimensional setup

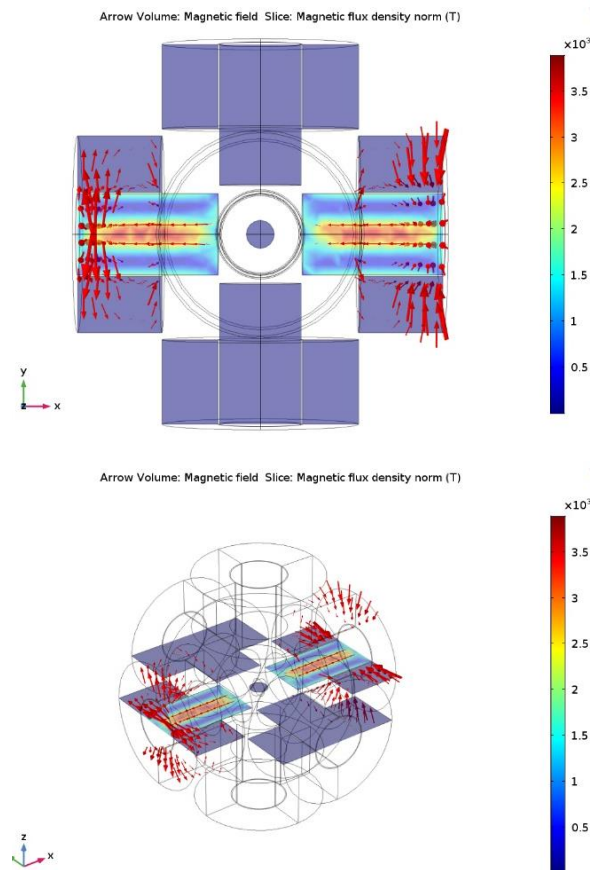
**Table 3.** The modelling Parameters of blood vessel

Parameter	Value	Unit
Chanel Length	2	mm
Branch Length	1	mm
Branch Angel	60	Degree
Blood Density	1050	Kg/m <sup>3</sup>
Blood Viscosity	0.04	Pa.s
Blood Temperature	293.15	K
Blood Relative Permeability	1	-
Air Relative Permeability	1	-

For instance,  $I_{x+}$  shows the current coil in the positive direction of the x-axis. The applied current in these three states is shown in Table 4. The magnetic flux due to the coils complex in the space, in the water sphere and the particle trajectory is shown in Figure 5-a, 5-b and 5-c. According to the applied current to the coils, the magnetic flux profile in the 3D setup and inside the sphere in the x-y plane is illustrated in Figure 5-a, specifically. This flux distribution shows the direction of the applied magnetic gradient, appropriately. As depicted, the trajectory of the nanoparticle is along to the determined direction by the applied magnetic gradient. Figure 5-b and 5-c similarly show this issue in predetermined directions in x-z and z-y planes.

To investigate the conduction of nanoparticles inside the vessel, the Y-shape equivalent vessel was placed at the center of the distance between the two coils. The blood flow was calculated by creeping flow physic. The inlet velocity of the channel was considered 5mm/s in the stationary state. Figure 6 shows the profile of the flow inside the channel.

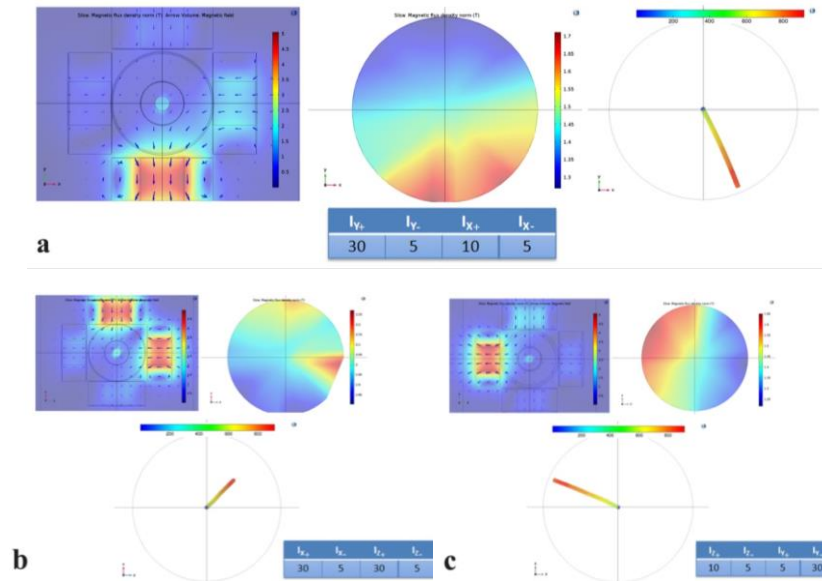
Figure 7 depicts the magnetic flux in the channel caused by a pair coil in the case in which the current in one coil and the other is 10 and 1 A. 100 particles with a radius of 500 nanometers, a density of 7200 Kg/m<sup>3</sup> and the relative permeability of 5000 was released uniformly at the channel inlet. The trajectory of these particles was calculated by particle tracing physic in 2 seconds (Figure 8).



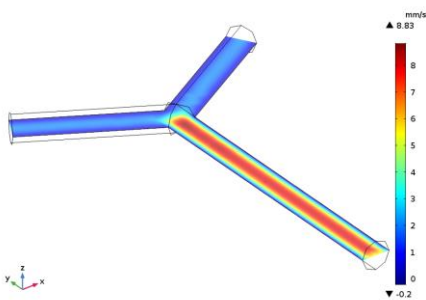
**Figure 4.** Magnetic flux (T: Tesla) generated by the coils in the x-direction with the current of 10 (A)

**Table 4.** The coil currents in different states

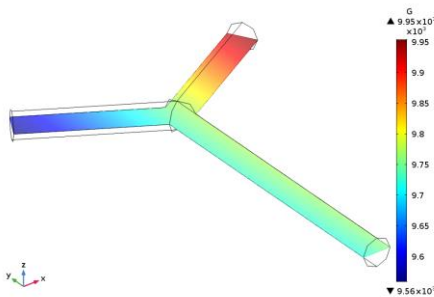
	$I_{x+}$	$I_{x-}$	$I_{y+}$	$I_{y-}$	$I_{z+}$	$I_{z-}$
<b>a</b>	10	5	30	5	0	0
<b>b</b>	30	5	0	0	30	5
<b>c</b>	0	0	5	30	10	5



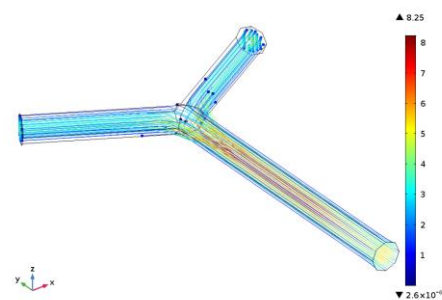
**Figure 5.** Magnetic flux (T) in space and inside the sphere in different planes and the trajectory of the nanoparticle in 60 seconds; a) The xy plane; b) The xz plate; c) The yz plane



**Figure 6.** Creeping flow profile inside the Y-shape channel

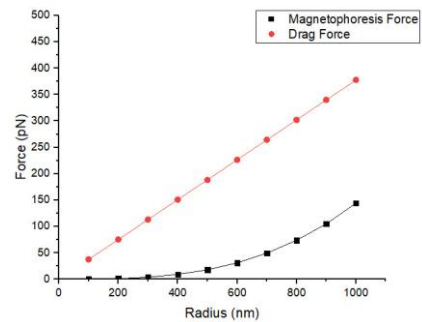


**Figure 7.** Magnetic flux in Y-shape channel (T) while the coil currents are 1 and 10 (A)

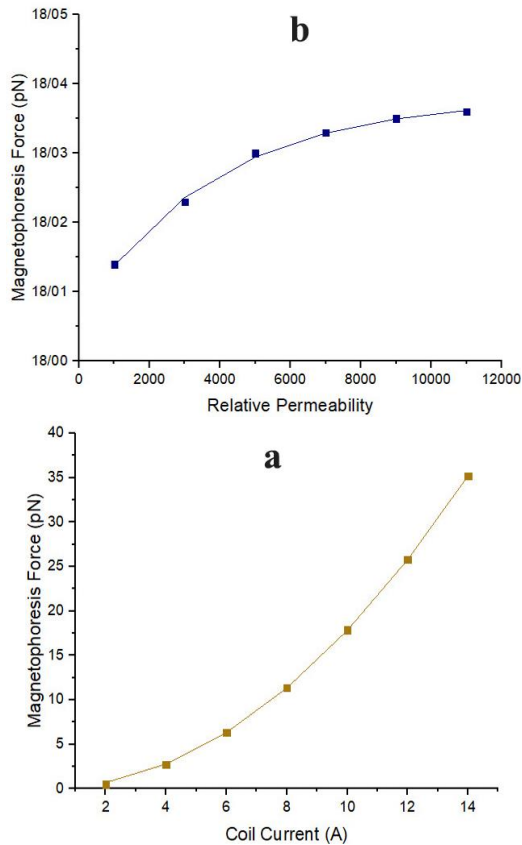


**Figure 8.** The trajectory of 100 particles with a radius of 500 nanometers for 2 seconds

The variation of the hydrodynamic and the magnetophoresis forces for the different particle radii from 100-1000 nm with the steps of 100 nm is shown in Figure 9. According to Equation 11, the hydrodynamic force linearly proportional to the particle radius. Moreover, as shown in Equation 9, which represents the relation between the magnetophoresis force and the cube of the nanoparticle radius, the limitation of using the nanoparticles with a smaller size is noticeable. Figure 10-a depicts the magnetophoresis variation for the current difference in a coil from 2 to 14 A while the current in another coil is 1 A. Increasing the current in one coil when the current in another coil is constant increases the generated magnetic gradient and magnetic saturation of the particles. These factors increase the magnetophoresis force, eventually. The magnetophoresis variation for the relative permeability of the nanoparticles from 1000 to 12000 with the steps of 1000 is shown in Figure 10-b.



**Figure 9.** The magnitude of magnetophoresis force and hydrodynamic force (pN) with radius variation (nm)



**Figure 10.** a) The magnitude of the magnetophoresis force (pN) for the change in coil current (A); b) Magnetophoresis force (pN) for changes in relative permeability of nanoparticles

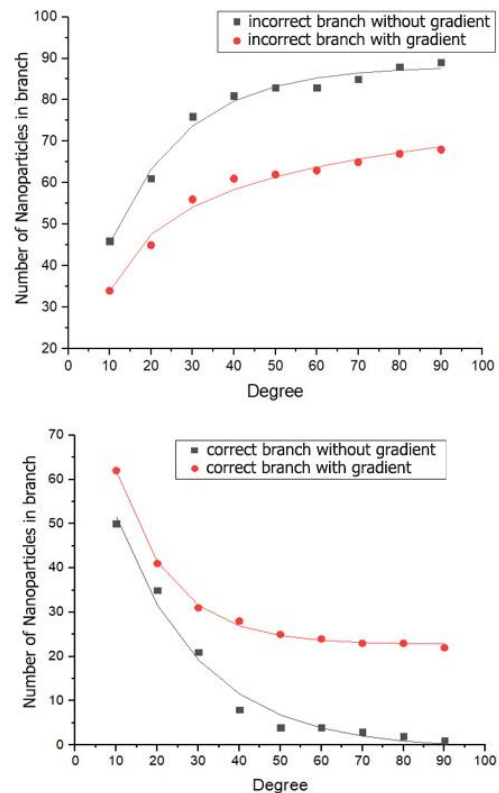
Changes in the relative permeability of nanoparticles alone do not play an effective role in increasing the magnetophoresis force. As shown, by multiplying this parameter by 10, changes about 0.03 pN are achieved. In general, due to the effect of the above parameters on the magnetophoresis force, the existing constraints can be greatly reduced by selecting the optimized values of these parameters.

The difference amount of the residual nanoparticles along to the main channel according to the angle variation of a branch relative to the primary direction of the channel in two cases of with and without applied magnetic field gradient is shown in Figure 11. To compute, different simulations in angles from 10 to 90 degrees with the steps of 10-degree were accomplished.

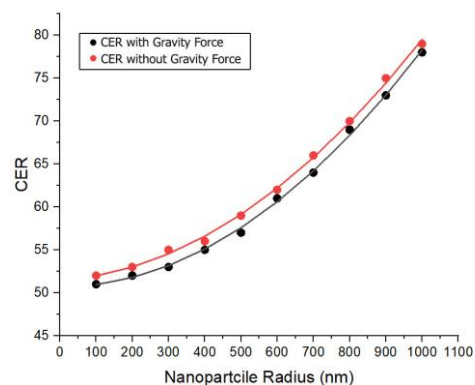
To evaluate the conductive performance of the system, the correct exit rate parameter was considered as the number of nanoparticles reached to the determined outlet. 100 nanoparticles were released into the inlet of the Y-shape channel uniformly. The amount of the nanoparticles reached to the correct outlet were

counted in a condition that the magnetic gradient was applied in the direction of the interested outlet.

The amount of Corrected Exit Rate (CER) for the radii of the nanoparticles from 100-1000 nm was calculated. The CER in two states of the effect of gravity force and without the effect of the gravity force for different radii of magnetic nanoparticles is shown in Figure 12. As depicted, increasing the radius of the nanoparticles increases the amount of the applied magnetophoresis force.



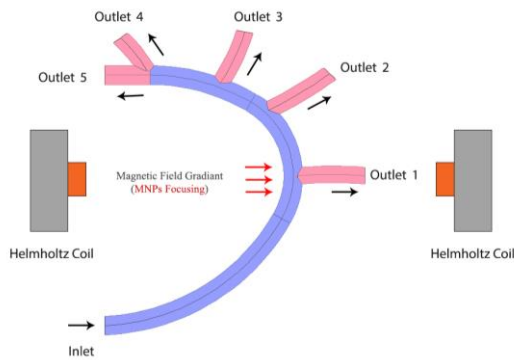
**Figure 11.** The output variations of the correct and incorrect channels simultaneously with changing the correct outlet angle



**Figure 12.** CER variations with the radius of nanoparticles (nanometers) in two states of with and without the effect of gravity



As a result, the number of nanoparticles reached to the correct outlet increases. Besides, the effect of the gravity force on the correct conduction of the nanoparticles is negligible and does not show a significant difference in two different states. In the modeled multi-branch channel, 5 states of the simulation were performed. In one state, the exit rate calculated without the magnetic gradient.

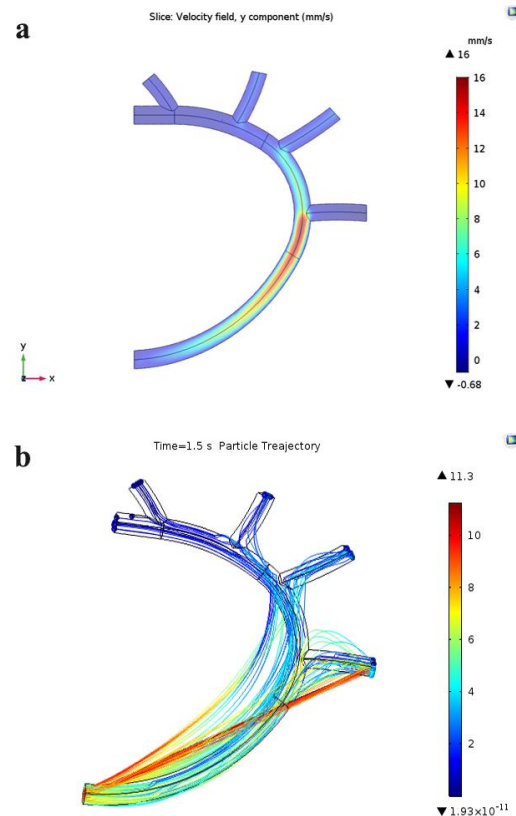


**Figure 13.** A simple model of applying a gradient along to the outlet 1 of a multi-branch vascular network

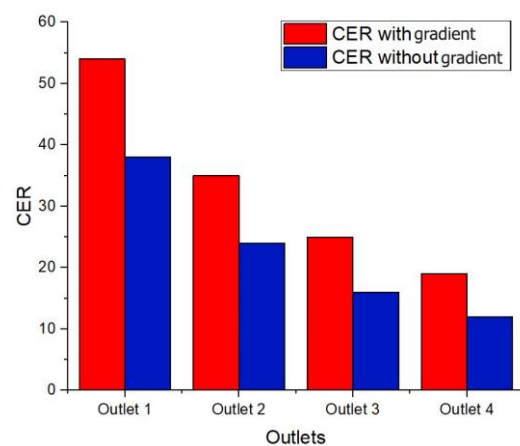
In another states, as shown in Figure 13 each time the magnetic gradient is applied to the direction of one of the outlets. 100 nanoparticles were released at the inlet of this vascular net. The number of nanoparticles reached to all outlets was counted in each simulation. Figure 14-a illustrates the creeping flow profile in the modeled vascular net. The trajectory of 100 particles for 2 seconds, while the magnetic gradient was applied to outlet 1 is shown in Figure 14-b. As depicted in Figure 14-b, the amount of the particles reached to the outlet 1 is more than other outlets. The amount of CER for all outlets in the states without gradient and with the applied gradient in the desired directions is shown in Figure 15. It should be noted that by increasing the distance of the interested outlet from the injection point, the amount of reached nanoparticles will be decreased.

#### 4. Conclusion

In this study, the performance of the magnetic conduction system for use in targeted drug delivery in Comsol Multiphysics software was investigated. In this numerical simulation, Helmholtz coils with different currents to generate a magnetic gradient were used. In most researches performed by the DCC method, only two magnetic and hydrodynamic forces have been assumed to be effective. In this study, in addition to the



**Figure 14.** a) Creeping flow profile in the multi-branch channel; b) The trajectory of 100 particles, magnetic gradient along to the outlet 1



**Figure 15.** CER at the outlet with and without magnetic gradient along its direction

two forces of magnetophoresis and hydrodynamics, the effect of gravity force was also considered on the correct conductivity of nanoparticles by the magnetic conduction system of the drug with the DCC approach. The conduction was simulated in the Y-shaped channel and in addition in the multi-vascular net. Moreover, the effect of angle variation relative to the main vessel on the correct conductivity of nanoparticles was evaluated.

The results of the first simulations in the water sphere showed that the magnetic nanoparticles move in a predetermined direction and the system performs correctly. By performing several simulations, the effect of several parameters includes particle radius, coil flow and relative permeability on the magnetophoresis force changes was determined.

Changes in the CER, in the states with and without the effect of gravity present a good estimate of the system conductivity. In both states, CER was calculated for different radii of nanoparticles inside the Y-shape channel and the results showed a reduction of 1.5 to 3% in the state with gravity. From the changes, it can be concluded with a good approximation that the effect of gravity on reducing the conduction efficiency of the system is negligible. The results of the multi-branch vascular network in this study showed that the CER of each branch increases by applying a gradient in its direction. The rate of increase is more significant when the conduction point is closer to the nanoparticle injection point. It seems that the smaller angle of the correct branch from the initial direction of the vessel and the greater angle of the secondary branch causes the higher CER.

In future studies, we intend to evaluate the performance of this magnetic conduction system in near-reality conditions inside the vessels. This is achieved by considering more influential forces. Using more realistic vascular networks in modeling is also another goal. In the future with the help of the obtained results, a laboratory sample of this magnetic conduction system can be made for practical studies in animal dimensions.

## Acknowledgments

This article has been extracted from the thesis written by Mr. Erfan Saadatmand at the school of medicine, Tehran University of Medical Science.

## References

1- Rotariu, O. and N.J. Strachan, "Modelling magnetic carrier particle targeting in the tumor microvasculature for cancer treatment". *Journal of magnetism and magnetic materials*, 293(1): pp. 639-646, 2005.

- 2- Zhou, W., et al., "Drug-loaded, magnetic, hollow silica nanocomposites for nanomedicine". *Nanomedicine: Nanotechnology, Biology and Medicine*, 1(3): pp. 233-237, 2005.
- 3- Arruebo, M., et al., "Magnetic nanoparticles for drug delivery". *Nano today*, 2(3): p. 22-32, 2007.
- 4- Permyakova, E.S., et al., "Synthesis and Characterization of Folate Conjugated Boron Nitride Nanocarriers for Targeted Drug Delivery". *The Journal of Physical Chemistry C*, 121(50): pp. 28096-28105, 2017.
- 5- Duskey, J.T., et al., "Novel peptide-conjugated nanomedicines for brain targeting: In vivo evidence". *Nanomedicine, Nanotechnology, Biology and Medicine*, 28: p. 102226, 2020.
- 6- Alexiou, C., et al., "Delivery of superparamagnetic nanoparticles for local chemotherapy after intraarterial infusion and magnetic drug targeting". *Anticancer research*, 27(4A): pp. 2019-2022, 2007.
- 7- Takeda, S.-i., et al., "Development of magnetically targeted drug delivery system using superconducting magnet". *Journal of Magnetism and Magnetic Materials*, 311(1): pp. 367-371, 2007.
- 8- Yesin, K.B., K. Vollmers, and B.J. Nelson, "Modeling and control of untethered biomicrorobots in a fluidic environment using electromagnetic fields". *The International Journal of Robotics Research*, 25(5-6): pp. 527-536, 2006.
- 9- Abbott, J.J., et al., "Modeling magnetic torque and force for controlled manipulation of soft-magnetic bodies". *IEEE Transactions on Robotics*, 23(6): pp. 1247-1252, 2007.
- 10- Alexiou, C., et al., "A high field gradient magnet for magnetic drug targeting". *IEEE Transactions on applied superconductivity*, 16(2): pp. 1527-1530, 2006.
- 11- Han, X., Q. Cao, and L. Li, "Design and evaluation of three-dimensional electromagnetic guide system for magnetic drug delivery". *IEEE transactions on applied superconductivity*, 22(3): pp. 4401404-4401404, 2011.
- 12- Choi, H., et al., "Two-dimensional actuation of a microrobot with a stationary two-pair coil system". *Smart Materials and Structures*, 18(5): p. 055007, 2009.
- 13- Jeon, S., et al., "Magnetic navigation system with gradient and uniform saddle coils for the wireless manipulation of micro-robots in human blood vessels". *IEEE transactions on magnetics*, 46(6): pp. 1943-1946, 2010.
- 14- Choi, H., et al., "EMA system with gradient and uniform saddle coils for 3D locomotion of microrobot". *Sensors and Actuators A: Physical*, 163(1): pp. 410-417, 2010.

- 15- Dadkhah, M., N. Kumar, and J. Yoon. "Design and simulation of a 3D actuation system for magnetic nanoparticles delivery system". in *International Conference on Intelligent Robotics and Applications*. Springer, 2013.
- 16- Roohi, R., H. Emdad, and K. Jafarpur, "A comprehensive study and optimization of magnetic nanoparticle drug delivery to cancerous tissues via external magnetic field". *Journal of Testing and Evaluation*, 47(2): pp. 681-703, 2019.
- 17- Tehrani, M.D., M.O. Kim, and J. Yoon, "A novel electromagnetic actuation system for magnetic nanoparticle guidance in blood vessels". *IEEE transactions on magnetics*, 50(7): pp. 1-12, 2014.